

THE END-FED HALF-WAVE ANTENNA

PRESENTED AT THE
GREATER NORWALK AMATEUR RADIO CLUB (GNARC.ORG)

November 14, 2018

Steve Dick, K1RF

About Half-wave Antennas

- ⦿ A half-wave antenna is a resonant radiating element with an electrical length of one half-wave. Total length in feet. $\sim 468 / \text{freq in Mhz}$. Its' feed-point affects its impedance. High current, low voltage at center; low current high voltage at ends.
- ⦿ The most common half-wave antenna is the center-fed dipole, whose impedance is approximately **72 ohms**. A dipole is basically a mono-band antenna. It is sometimes used on its 3rd harmonic with coax, or used multiband as a doublet with balun, ladder line and wideband tuner.)
- ⦿ If fed off center, say at 30%-70% point, impedance is approximately **200 ohms** and can be used on multiple bands with an antenna tuner. Works with a 4:1 UNUN. See [this link](#) for more info. 4:1 impedance ratio is 2:1 turns ratio.
- ⦿ If fed at the end (a.k.a EFHW), antenna impedance is in the **2000-4000 ohms** range. It requires a high impedance matching device: Either a tapped resonant circuit, a Zepp type coupling circuit, or a high impedance ratio UNUN (49:1 or 64:1) It can be used on multiple bands. With a 49:1 or 64:1 UNUN, no tuning is required and no antenna tuner is required (or perhaps a “touch up” tuner with up to 3:1 VSWR capability that many modern rigs have built-in.)

What are the advantages of an EFHW fed with an UNUN compared to other wire antennas?

- ⦿ Ease of installation. Only a single high point required. Makes a great antenna for field use with quick setup.
- ⦿ Many configurations possible to suit your installation: Horizontal, Inverted V, Inverted L, Sloper, etc
- ⦿ No hanging feedline. Feed point is near the ground.
- ⦿ Minimal ground system or counterpoise needed – the coax feed itself can act as a counterpoise
- ⦿ Resonant on 80/40/30/20/17/15/12/10m with low VSWR. No tuner needed or just a 3:1 “Touch-up” tuner
- ⦿ Reduced coax losses as a result of low antenna VSWR.
- ⦿ One simple length adjustment – no interactions between bands.
- ⦿ Grounded at D.C. No static buildup.
- ⦿ Shortened versions possible for limited area

Multiband operation of a Half-Wave Antenna

- If the half-wave antenna can be impedance matched on all of its harmonics, you now have a multiband antenna.
- On the fundamental frequency, antenna pattern is identical no matter where you feed it.

$3.57 \times 1 = 3.57$ MHz	80M
$3.57 \times 2 = 7.14$ MHz	40M
$3.57 \times 3 = 10.71$ MHz	30M
$3.57 \times 4 = 14.28$ MHz	20M
$3.57 \times 5 = 17.85$ MHz	17M
$3.57 \times 6 = 21.42$ MHz	15M
$3.57 \times 7 = 24.99$ MHz	12M
$3.57 \times 8 = 28.56$ Mhz	10M

But a key characteristic that does change is the radiation pattern on each harmonic. This IS affected by where the half-wave is fed.

Conventional 1:4 and 1:9 UNUNs

- These UNUNs belongs to a class of devices known as “**transmission line transformers**”, which are formed by winding bifilar turns, multi-filar turns, coaxial cable, or stripline cable (two strips of the flat conductor with a dielectric material between the strips) on a core having high permeability.
- 1:4 UNUNs ($Z_{out}=200$ ohms) are typically used for off-center-fed (OCF) dipoles, Zepps, and 43 foot multiband verticals and **random length** (non-resonant) wires
- 1:9 UNUNs ($Z_{out}=450$ ohms) are typically used with **random length** non-resonant wire antennas
- At low frequencies, like all transformers, they require adequate primary inductance at lowest freq.

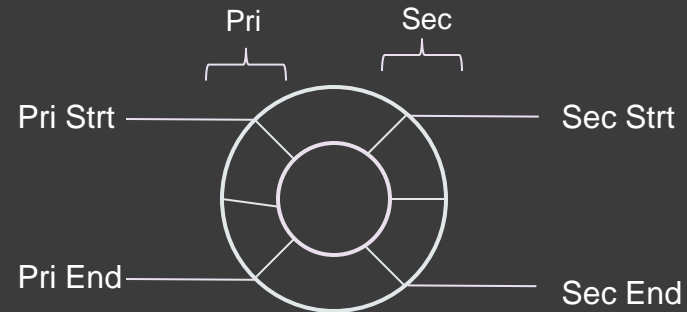

Standard Transformer

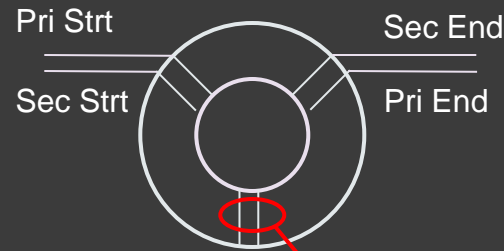

Transmission line (twisted or parallel pair)



Bifilar Wound Transmission Line Transformer

Transmission line transformers exhibit very wide bandwidth (1-54 MHz), high power capability (2-5KW), and high efficiency

Some Applications of the 4:1 UNUN

○ Variants of the modern [W3EDP Zepp](#)

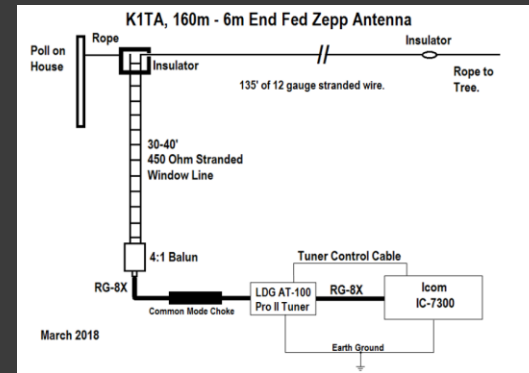
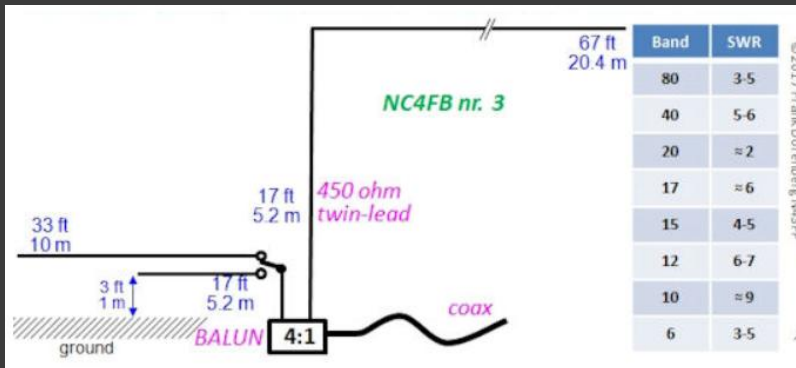

Courtesy Tom, K1TA

○ Off-Center-fed Antenna

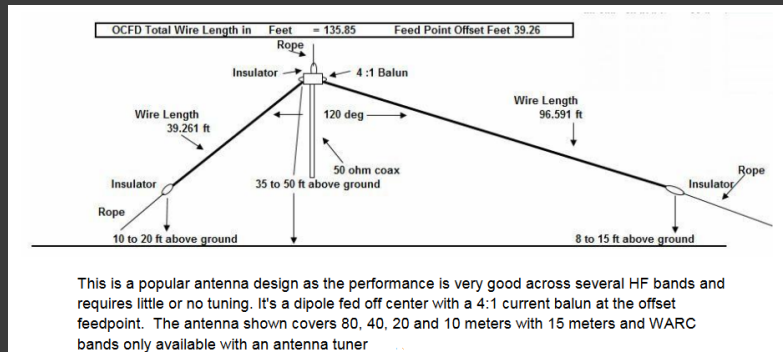

Courtesy Balun Designs

- 160 through 6 meters!
- 4:1 balun is wideband and allows this to work.
- Requires wideband tuner: High SWR on even harmonics and more feedline radiation

These usually require wide range antenna tuner

Application of 9:1 UNUN

- Emergency Amateur Radio Club of Hawaii (EARCHI) marketed a matchbox-kit for a 6-40 mtr multi-band end-fed antenna. Uses non-resonant antenna (Recommended antenna wire length: 24-30 ft (60 ft max) and **powdered iron toroid**, efficient transmission line transformer

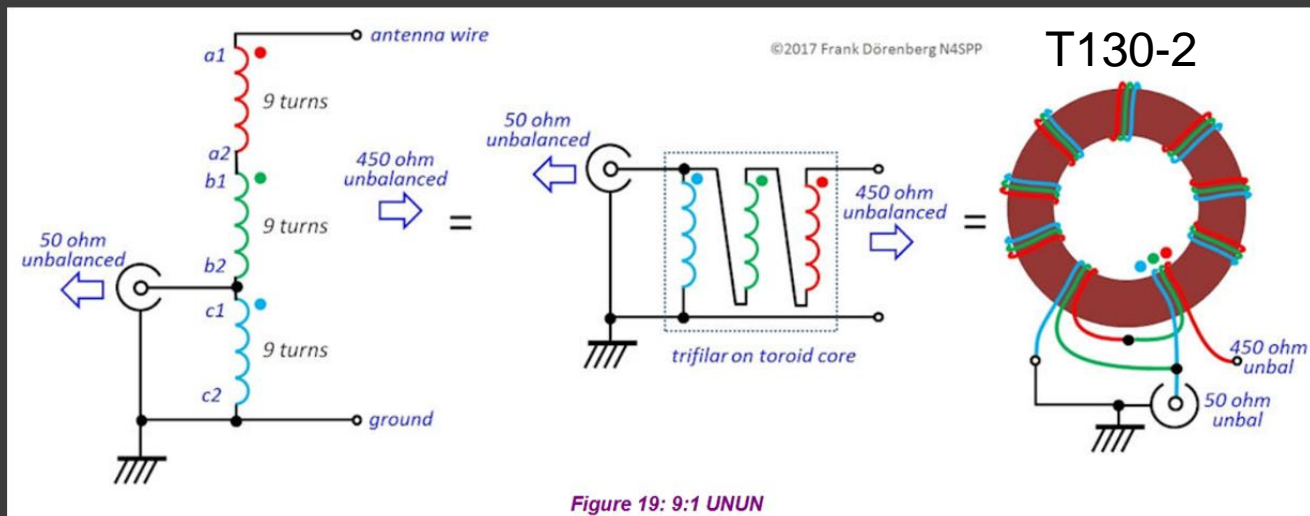

Short Non-resonant antenna requires wide range antenna tuner

High Impedance UNUN for EHF antenna

- The UNUN has a high impedance ratio (49:1 to 64:1) – not feasible to use transmission line transformers whose practical limit is about 16:1. It is a conventional transformer.
- Uses a ferrite toroidal core or cores (usually Type 43 or type 52 material). Most 1:4 and 1:9 transmission line UNUNs use powdered metal cores (such as -6) having much lower permeability, not suited for an EHF UNUN.
- Bandwidths support about a 10:1 frequency bandwidth (3-30 MHz)
- Two important UNUN parameters are core primary inductance and efficiency.

***Less bandwidth (80-10M) and more lossy than the 4:1 or 9:1 UNUNs ---
But it still works fine and does the job.***

High Impedance UNUN for EHFV antenna

cont'd

○ Primary inductance

- If primary inductance is too small at the low frequency end, Mismatch loss is significant and high VSWR results.
- If primary inductance is too high, the high frequency performance suffers and VSWR climbs at the high end.
- My rule of thumb: Inductive reactance (X_L) should be in the 88 ohm- 200 ohm range at the lowest frequency of use ($X_L = 6.28 * F * L$ where (X_L is inductive reactance in ohms, F is frequency in MHz, and L is inductance in microhenrys.). This corresponds to 4-9 microhenrys at 3.5MHz or 2-4.5 microhenrys at 7 MHz .
- Toroid primary inductance increases with size of toroid. Two FT140 sized toroids have about the same inductance as a single FT-240 sized toroid for the same number of turns.
- Toroid primary inductance is proportional to the number of toroids.

High Impedance UNUN for EHF antenna

cont'd

○ Efficiency

- Good designs should support efficiencies in the range of 80-90%+
- For signal strength, It makes little difference.
- For dissipated power in the toroid(s), it makes a big difference.
- At 50 watts continuous and 75% efficient toroid(s), power dissipation in the toroid is 12.5 watts.
- At 50 watts continuous and 85% efficient toroid(s), power dissipation is 7.5 watts: 60% of the 75% efficient toroid!
- CW duty cycle is ~ 44% of continuous power
- SSB duty cycle is 25% of continuous power (very conservative)

EFHW UNUN Construction

For 100W+,
I recommend
at least 2 toroids
for better efficiency,
higher primary
inductance, and
splitting power
between toroids

Number of turns
= number inside
the toroid stack.
Crossover counts
as one turn

49:1 Transformer

Primary 2 Turns.
Secondary 14 turns (Total turns)

To End Fed Half Wave Antenna.

“Crossover”

Parts List

Toroid Core:
Mouser Part #623-5943003801
240-43 Toroid 12.7mm x 61mm

**Use 1, 2 or 3 cores depending on transmitter output to be used.*

Capacitor:
Mouser Part #81-DHR4E4C221K2BB
100 - 110 pF. You can use TWO
220 pF @ 15 kV in series.

Antenna:
80m - 10m use a 134' wire.
40m - 10m use a 67' wire, etc.

Wire:
14 gauge enameled wire.**

*** When using 3 toroid cores start with a Primary wire of ~13" and Secondary of ~80" long. 1 & 2 cores will use less wire.*

100 pF

To TX Gnd.

Revised: 07/14/2017 - K1TA

I recommend 2 type 43 material for less than ~250 watts for lower cost, Fair Rite P/N 5943003801

3 type 52 material for ~500-1000W higher efficiency and higher temperature capable. Fair Rite P/N 5952003801

EHFW Antenna Construction

The coax going to the UNUN can serve as a counterpoise.
A separate counterpoise wire is optional.

A choke balun is optional but must be installed near the rig, never near the UNUN

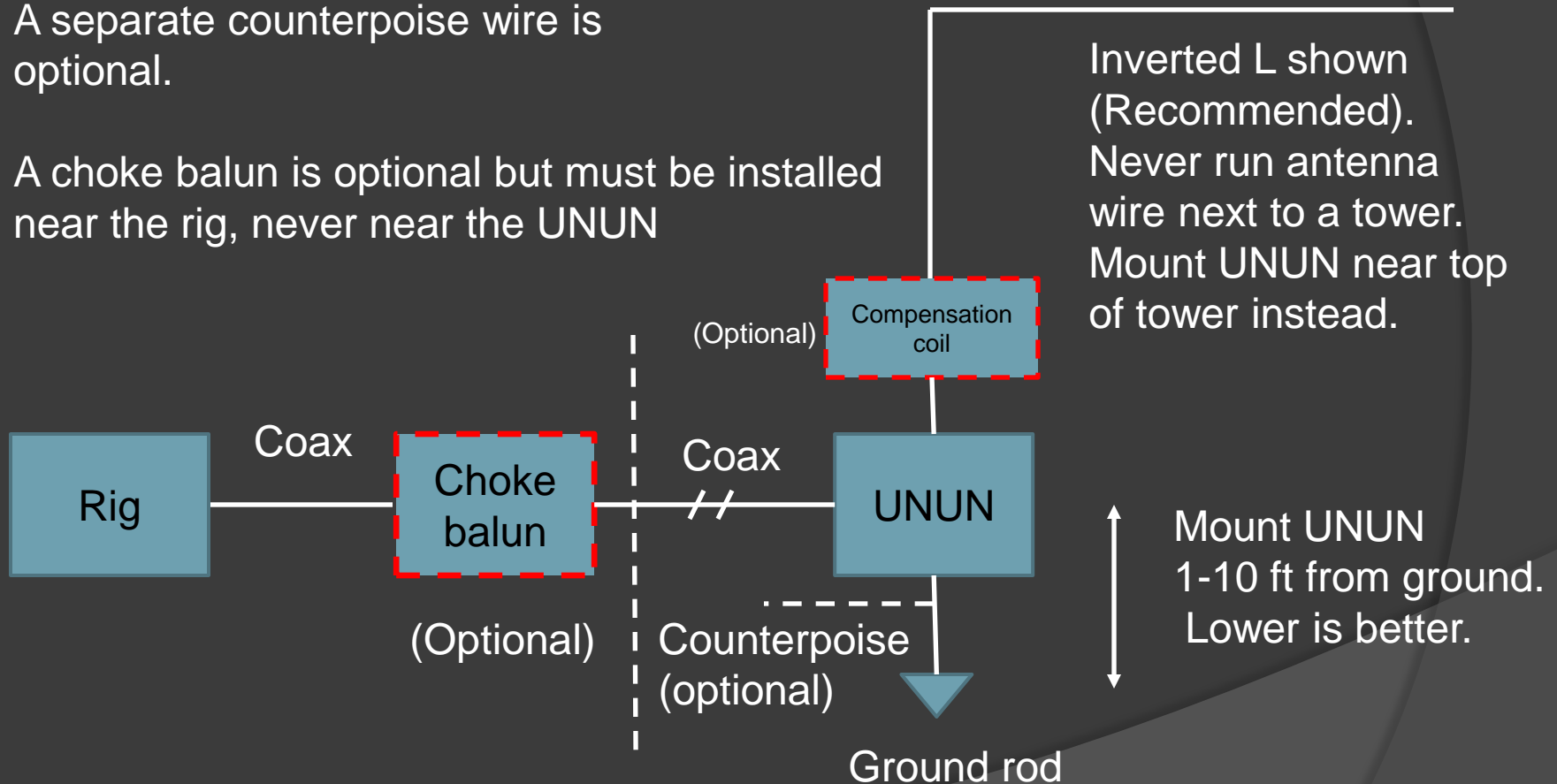

EFHW Counterpoise

- Current flowing into the antenna's end must be equaled, at that end point, by the same amount of current flowing into a ground or counterpoise of some type.
- If you don't specifically provide one then the coax shield will act as the counterpoise.

For a suspended counterpoise wire, the "ideal" length would be $1/4$ wavelength, providing low impedance at the feedpoint. But for multiband use, it should be non-resonant on any band. Because the feed impedance on an end-fed $1/2$ wave is high, you can get away with a lot shorter counterpoise. The higher your counterpoise impedance, the more current will flow in the outside of the coax shield, so its a trade off. Many get away with just using the coax shield as the counterpoise (which some manufacturers advertise as "no counterpoise").

- If you are near a wire fence, connect the ground to it. that makes a great counterpoise.
- If you have a good radial system, that will be a great counterpoise with minimal currents flowing on the coax.

More info on counterpoise [here](#)

Is a Choke Balun needed?

- Generally speaking, no. Depending on the quality of your counterpoise, current splits between the counterpoise and coax shield.
- You can use a choke balun, but it must be used at the rig end of the coax feed, or along the coax where a segment acts as a counterpoise, NOT next to the UNUN unless you have a counterpoise, or you will have no counterpoise and the EFHW will not work.

Ferrite Materials

Material	Initial Permeability	Relative cost	Core loss	Curie Temperature	Comments
Fair Rite 43	800	Moderate	Moderate	>130 degC	Power < 200 W CW
Fair Rite 52	250	High	Low	>250 degC	Power > 400 W CW
Fair Rite 61	125	High	Low	>300 degC	DO NOT USE Permeability too low!

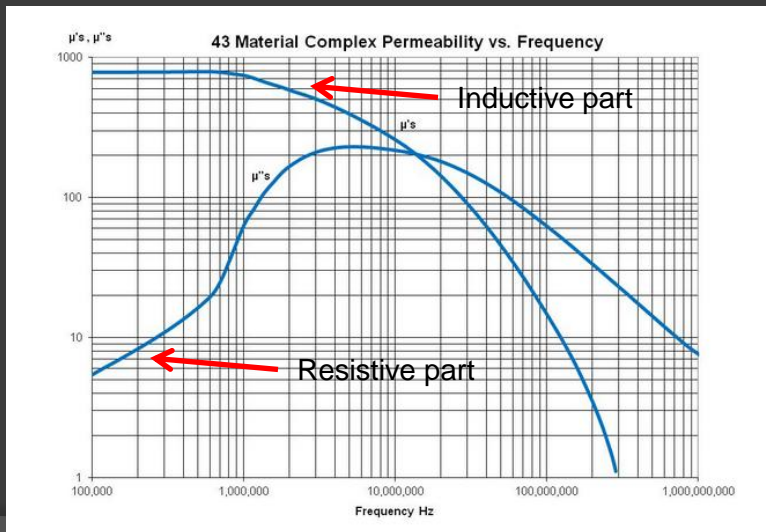

Permeability is actually complex - it has an inductive component (μ') and a resistive (lossy) component (μ'')

Inductance typically gets smaller with frequency

Never use powdered iron cores for a EFHW UNUN – permeability is way low.

100pF compensation capacitor

- ◉ A 100pF capacitor is part of the UNUN antenna matching circuit. It is placed across the primary of the UNUN to improve high frequency UNUN performance.
- ◉ Helps to compensative mainly for UNUN primary leakage inductance.
- ◉ The value of 100pF works well for most UNUNs, small or large, low power or high power.
- ◉ Typically uses a ceramic disk “blue cap” 3KV or more. These caps typically have a high current rating as they must handle several amps of RF current.
- ◉ Voltage rating can be increased by putting two 200 pF caps in series. Current rating can be increased by putting two 47pF caps in parallel.
- ◉ For QRP rigs, a silvered mica 100pF 500V or 1KV rated cap is fine. Search EBAY for 100pF silver mica, mouser.com, digikey.com
- ◉ Sources of 100pF high voltage caps:
 - EBAY (search for 100pF capacitor. Select a “blue cap”, 3KV or more
 - Mouser P/N 81-DHR4E4C221K2BB (220pF, put two in series. Ceramic disk 15KV rated, \$1.23 each



UNUN performance without and with compensation cap (100pF)

Increasing SWR due to UNUN leakage inductances

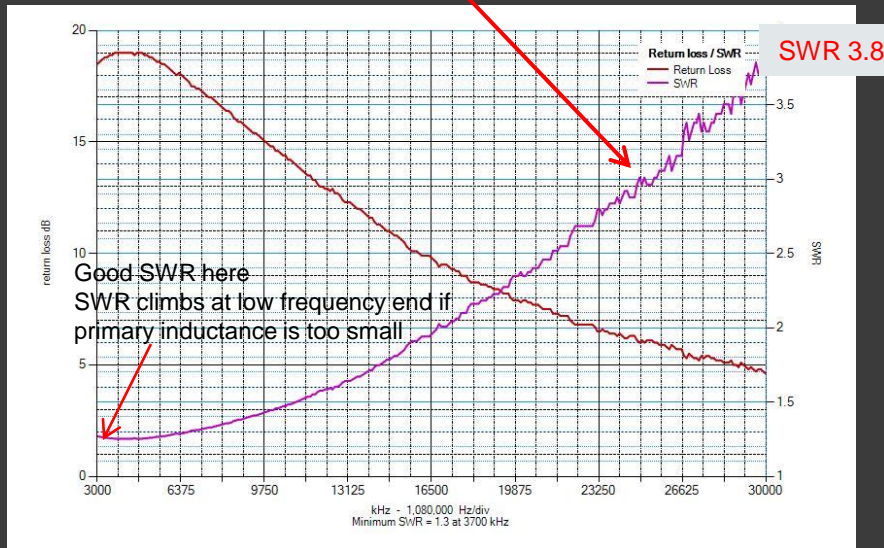

QRP Unun 3/21 wind Rload=2450
VSWR without 100pF capacitor

SWR improved in upper frequencies

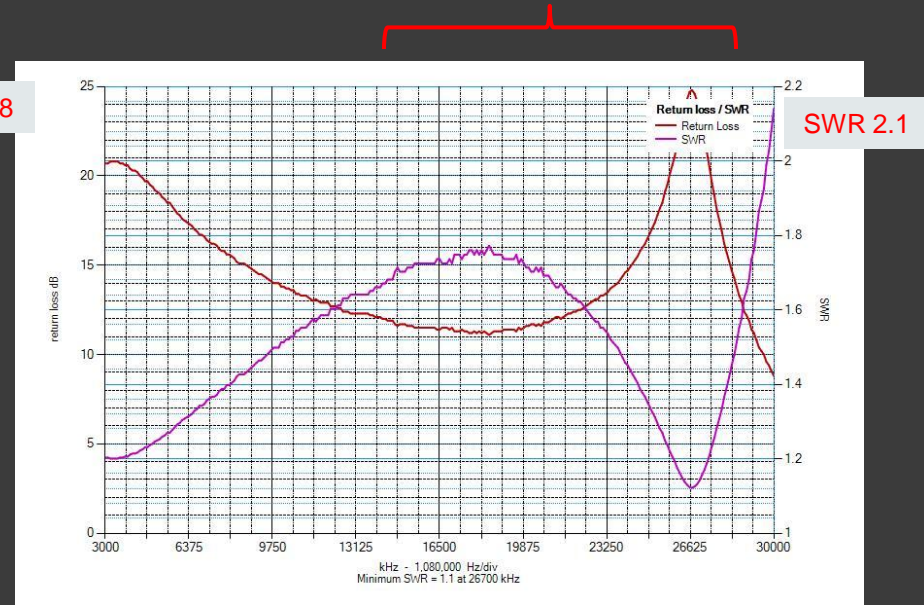

QRP Unun 3/21 wind Rload=2450
VSWR with 100pF capacitor

The compensation capacitor compensates mainly for UNUN primary leakage inductance and improves VSWR at upper end

SWR plot on real antenna vs. resistive load

- SWR plot looks very different from a resistive termination and typically improves when driving a real antenna!
- That's because if the antenna operates slightly above resonance, it looks capacitive. That capacitance series-resonates with unun secondary leakage inductance, effectively cancelling it out!

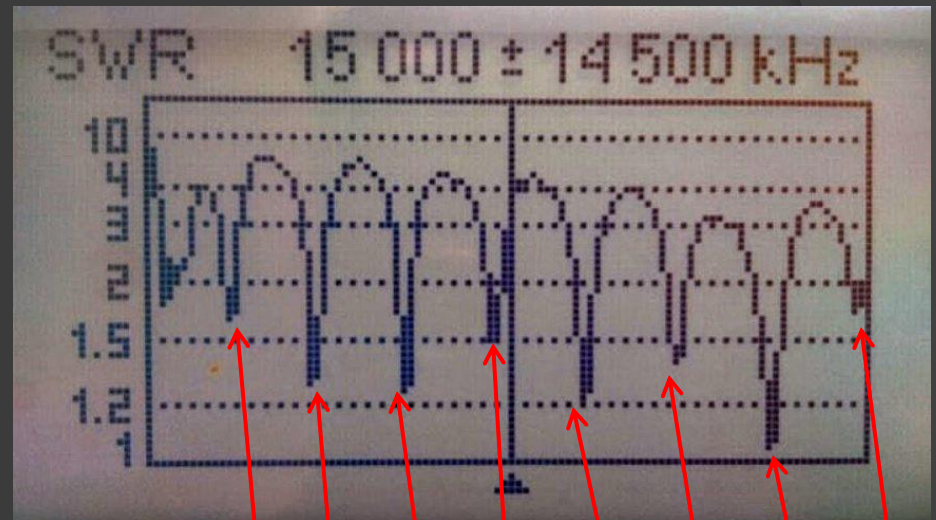

80 40 30 20 17 15 12 10
3.5 7 10.5 14 17.5 21 24.5 28

Look Ma! Typical SWR plot with
No antenna tuner! Pretty nice!

What does that small “compensation coil” do?

- The small coil, used on some commercial antennas, is used to compensate the resonant point of the high bands.
~1.5microHenrys 6T on 1.25” OD inch PVC form positioned at 78 inches from the feed point whether 80M EFHW or 40M EFHW. See Steve Ellington’s [youtube video](#) on this topic. It lowers resonant point more and more at increasing frequencies.

- 80M – lowers 22KHz
- 40M – lowers 57 KHz
- 20M – lowers 170 KHz
- 15M – lowers 400 KHz
- 10M – lowers 1 MHz



Recommendation: For homebrew antennas, use coil if you’re primarily a CW operator, don’t use coil if you’re primarily a SSB operator. Or leave it out and use “touch-up” antenna tuner.

If 80 meter resonant point is too low (for SSB) on 80 meters

- You can add a small capacitor roughly in the middle of the antenna wire. Value 250pF-500pF. This is mounted at a high current point. The “blue” ceramic high voltage caps work.
- This cap has little effect on the higher frequency bands.

Shortened EFHW Antennas

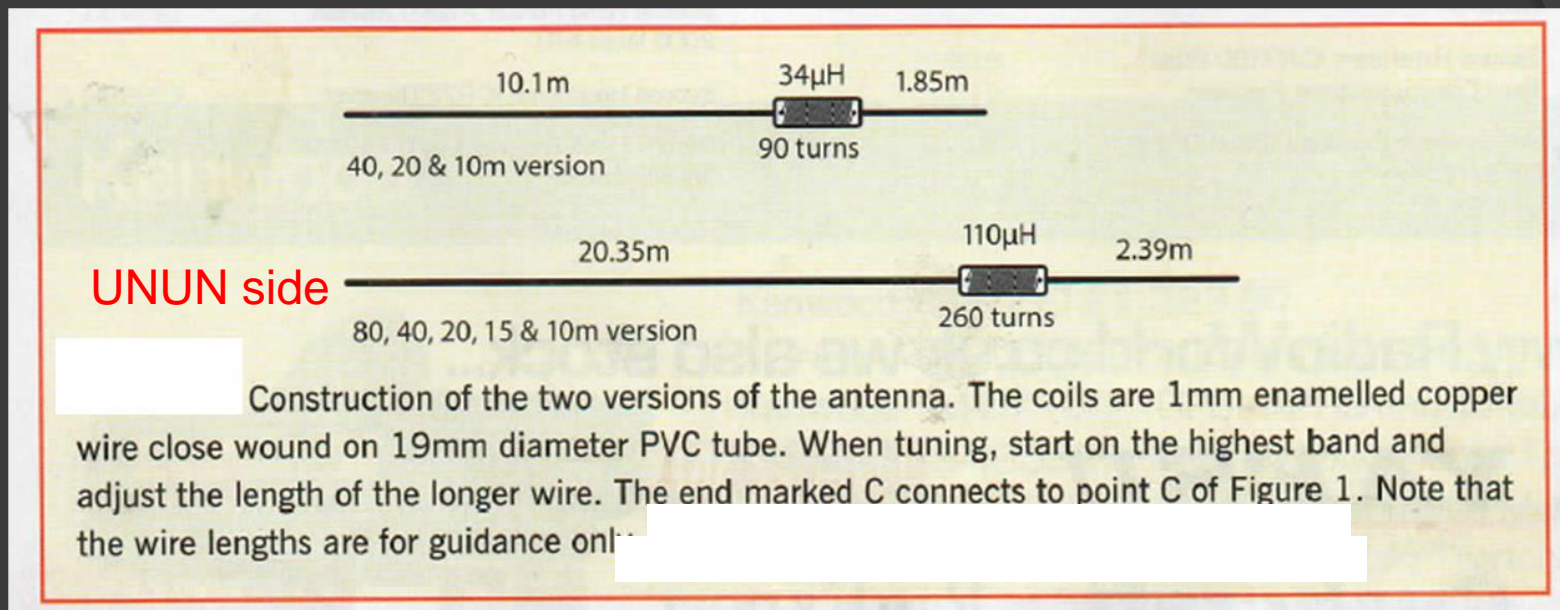

34uH coil: 90T, 110uH coil: 260 turns, 1mm (AWG #18) wire on 19m PVC tube. Adjust the long wire first for the high end bands. Then adjust the short wire for the lowest band.

Courtesy Jos Van den Helm, PA1ZP, RSGB February 2016.
"A Three of Five Band End Fed Antenna"

Adding 160 Meter Capability to an 80M-10M EFHW Antenna simply



Disconnect UNUN from coax feed. Connect jumper between coax feed and antenna, leaving UNUN “float”. The EFHW becomes a quarter wave antenna on 160 meters. Needs a good ground system to work properly.

More into at:

https://www.youtube.com/watch?v=u_SFS5FIM-w

Air venting the UNUN housing

- ◉ Why Air Vent?
 - Equalizes temperature and pressure
 - Minimizes internal condensation
 - Transformer runs cooler
- ◉ For ~100W rigs, two small 1/16" holes drilled on bottom of housing is sufficient
- ◉ For high power (>500w) multiple screened air vents are recommended
- ◉ Commercial vent:
Amphenol **VENT-PS1YBK-N8001 \$2.90**
Some commercial UNUNs now use this type of venting for pressure equalization



Use of 1,2,or 3 toroids

- ⦿ You can't simply add toroids for more power handling. You also have to pay attention to efficiency and primary inductance – both are ferrite material dependent.
- ⦿ More than 1 toroid generally improves efficiency:
 - Single FT240-43, 2T/14T wind is 66.5% efficient on 80M and has inadequate primary inductance/high VSWR. For a 100W rig on CW, dissipates 14.7 watts – much too high.
 - Two FT240-43 2T/14T wind is 83.25% efficient, for a 100W rig, dissipates 7.4W on CW (3.7W per toroid) with good primary inductance/VSWR. Runs cool as the proverbial cucumber.

Spend that extra few bucks, if necessary, for better performance

Recommended UNUN configurations

For:	Comment	Approx. Power rating, W			Toroid size/matl	Toroid qty	MFR	MFR P/N	AWG Wire Size	Primary turns	Secondary Turns	capacitor pF	Efficiency 80M-10M
		Digital	CW	SSB									
QRP	low cost, tiny, hard to wind, efficient	5	12.5	20	non-standard	1	Fair-Rite	2643625002	22	3	21	100	90.1-93
QRP	recommended	15	37.5	60	FT140-43	1	Fair-Rite	2643802702	16	3	21	100	81.55-86.95
QRP Plus	2X power than single FT140-43 and compact	30	75	120	FT140-43	2	Fair-Rite	2643802702	16	2	14	100	79.25-85.3
100w+	recommended	85	212	340	Ft240-43	2	Fair-Rite	5943003801	14	2	14	100	84.1-88.1
High power	good for 40-10. high efficiency. Primary inductance too low on 80 meters (3uH)	170	425	680	F240-52	2	Fair-Rite	5952003801	14	2	14	100	98.2-88
High power	recommended	300	750	1200	FT240-52	3	Fair-Rite	5952003801	14	2	13	100	98.6-92

Notes:

1. All UNUNs listed have >80% efficiency and adequate primary inductance unless otherwise specified. Relative cost taken into account for recommendations.

2. An alternate to the FT240-43 is a similar size toroid made by Laird Technologies with their type 28 material. 28B2400-000. Digikey P/N 240-2120-ND

This material has higher permeability than Type 52 but lower permeability than type 43. It may be substituted for the FT240-43 and has similar efficiencies.

3. The 100pF cap should be at least 3KV for 100+ watt rigs, at least 6KV for high power. For QRP, a silvered mica cap, 500V-1KV rated can also be used.

All UNUNs listed have >80% efficiency and adequate primary inductance. Green are recommended for relative cost and ease of build

Common Errors in building homebrew EFHW UNUNs

- ⦿ Using wrong toroid materials. Stay away from type 61 ferrite cores **and any powdered iron cores like -2 or -6**. Primary inductance too low and it won't work.
- ⦿ Putting insulating tape on toroids. (doesn't need it and degrades performance by adding an air gap from wire to toroid. Ferrite toroids used in these UNUNs have very high resistivity.
- ⦿ Counting wrong number of turns (turns are turns that pass through the inside, including the crossover turn)
- ⦿ Running parts of the antenna next to a metal tower (Put the UNUN at top of the tower, not at base with antenna next to tower)
- ⦿ Putting a choke balun right next to the UNUN. If used, it should be near the rig or the antenna has no counterpoise and won't work.
- ⦿ Confusion about what antennas are appropriate for 4:1 and 9:1 UNUNs. These are used with **non-resonant antennas**, not EFHWs
- ⦿ Putting too much power into an undersized UNUN. Many manufacturers have exaggerated claims for power handling capability. Toroids will overheat, SWR climbs as Curie temperature reached. But the toroid(s) will recover after cooling.

Commercial EFHW antennas and UNUNs for EFHW antennas

◎ Recommended:

- <https://myantennas.com/wp/>
- <https://www.hyendcompany.nl/>
- <https://www.gwhip.co.uk/>
- <https://www.inrprecision.com> EndfedZ antennas
- <https://qrpguys.com/> (for low cost QRP)

◎ Not Recommended:

- <http://www.mfjenterprises.com/> MFJ198XXP
- Most stuff on EBAY

QRPGuys.com QRP antenna



Low cost (\$15.00)

Clever design for portable use.

Rated <math><2:1</math> SWR, 10 watts

But... Uses an FT82-43 toroid. According to my analysis, only about 70-76% efficient and primary inductance on 80 and 40 too low.

Some EFHW UNUNs I have built

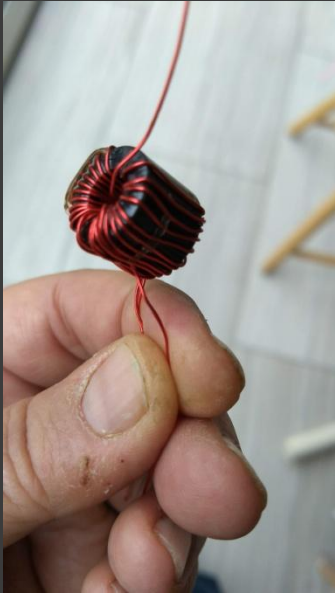

QRP UNUN
>90% efficient
80-10M
5W continuous,
10W CW,
20W SSB



Workhorse UNUN
2 FT240-43
84-88% efficient
80-10M
85 W continuous,
212W CW.
340W SSB



Test setup with 2 FT140-43
Small "QRP Plus" UNUN
80-10M
80-85% efficient
30W continuous
75W CW
120W SSB

Sources of materials

- Toroids – arrow.com, mouser.com, digikey.com, kitsandparts.com
- 1 post stainless wire rope clip: [Amazon.com](https://www.amazon.com)
- Enamel wire: [Amazon.com](https://www.amazon.com). Search on 14 gauge copper magnet wire. TEMco, Essex good brands.
- Stainless steel 1/4" hardware: Home Depot, Lowes, mcmaster.com.
- 4"X4"X2" PVC junction box (Carlson E989NNJ-CAR) [Home Depot](https://www.homedepot.com) or Lowes
- Cable Tie Base Saddle Type Mount Wire Holder 100 pcs – Enay or [Amazon](https://www.amazon.com)
- 100pF high voltage capacitors – [Ebay](https://www.ebay.com)
- Wire rope thimble (optional) Amazon or marine supply house. Relieves strain around eye bolt

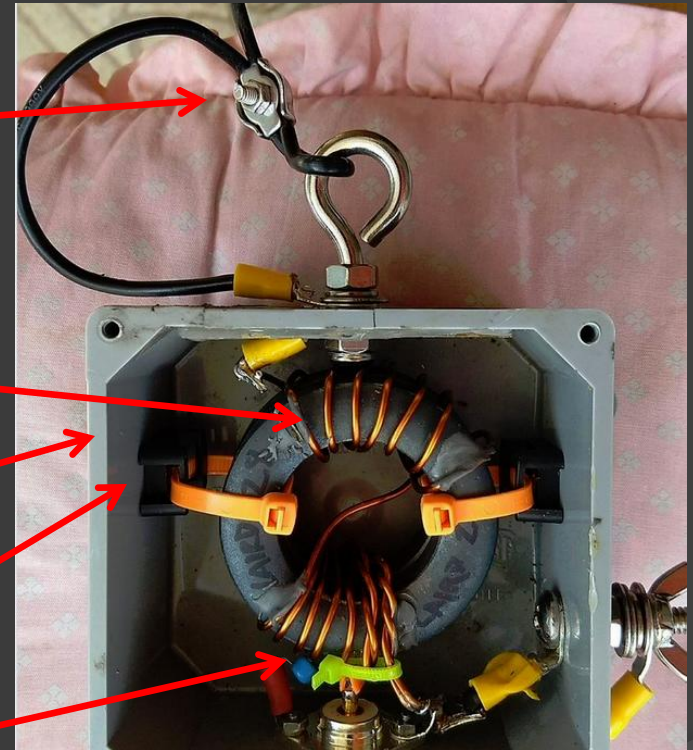

Resources

- Facebook group End Fed Half Wave Antennas >7000 members, run by Steve Ellington
- [Review of MyAntennas End Fed Half Wave Antenna 80-10 meters by Joel Halas, W1ZR, QST magazine, Mar. 2016](#) (Needs ARRL member login)
- [Endfed Halfwave antenna patterns \(look under EFHW\)](#)
- [Toroids.info Dimensions and inductance computation](#)
- [Calculate ferrite cored inductor parameters by Owen Duffy](#)
[Ferrite complex permeability tables for commonly used materials](#)
[All Owen Duffy on-line calculators](#)
- [Good resource on End-fed Antennas](#)
- [W3EDP Multiband Zepp type antenna](#)
- [All-band inverted L by Cebik before EFHW but shows antenna patterns](#)
Good insights into inverted L antenna advantages over doublet
- [Info on EFHW Counterpoise](#)
- [Video on protective vent](#)